

VOGUE
APPLIANCES

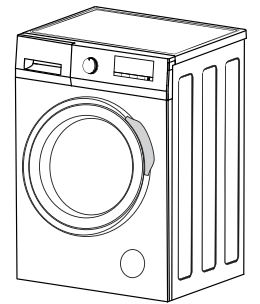

INSTALLATION INSTRUCTIONS USER GUIDE

VOGUE Front Load Washing Machine 9kg

360490 | 360491

To prevent the risk of accidents or damage to the appliance, it is essential to read these instructions before it is installed and used for the first time

PREFACE

This washing machine conforms to current safety requirements. Inappropriate use can, however, lead to personal injury and damage to property. To avoid the risk of accidents and damage to the washing machine, please read this manual carefully before using it for the first time. They contain important information on its installation, safety, use and maintenance. Keep this manual in a safe place for future reference.

Contents

Safety notices	1
Parts and features	3
Installation	4
The functions of the control panel	7
How to use washer	10
Cleanness and Maintenance	13
Troubleshooting guide	15
Technical parameters	16
Electric Diagram	17

Safety Notices

Before Use

WARNING

Read and understand thoroughly this safety instructions before use. The items indicated here are very important safety precautions, which must be followed. Any failure and losses caused by ignoring the above mentioned items and cautions mentioned in the operation and installation instruction are not covered by our warranty and any liability.

The appliance can be used by children aged from 8 years and above and persons with reduced physical, sensory or mental capabilities or lack of experience and knowledge if they have been given supervision or instruction concerning use of the appliance in a safe way and understand the hazards involved.

Children shall not play with the appliance. Cleaning and user maintenance shall not be made by children without supervision.

The rear surface of appliance shall be placed against a wall.

The appliance must not be supplied through an external switching device, such as a timer, or connected to a circuit that is regularly switched on and off by a utility.

The new hose-sets supplied with the appliance are to be used and that old hose-sets should not be reused

Technical safety

- Before setting up the washing machine, check it for any externally visible damage. Do not install or use a damaged washing machine.
- Before connecting the washing machine, ensure that the connection data on the data plate (voltage and current) match the electricity supply. If in any doubt, consult a qualified electrician.
- The electrical safety of this washing machine can only be guaranteed when continuity is complete between it and an effective earthing system which complies with current local and national safety regulations. It is most important that this basic safety requirement is present and regularly tested, and where there is any doubt the household wiring system should be inspected by a qualified electrician. The manufacturer cannot be held liable for the consequences of an inadequate earthing system.
- Do not connect the washing machine to the mains electricity supply by an extension lead. Extension leads do not guarantee the required safety of the appliance.
- Unauthorized repairs could result in unforeseen dangers for the user, for which manufacturer cannot accept liability. Repairs should only be undertaken by an approved service technician. Ensure current is not supplied to the machine until after maintenance or repair work has been carried out.
- If the supply cord is damaged, it must be replaced by the manufacturer, its service agent or similarly qualified persons in order to avoid a hazard.
- when these parts are fitted can the safety standards of the machine be guaranteed.

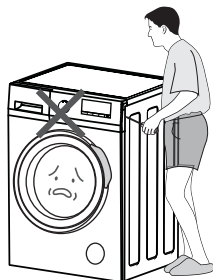

THIS WASHING MACHINE MUST BE EARTHED

Safety Notices

Before Use

Correct use

- To avoid the risk of personal injury or damage to the washing machine, do not install it in place where it is damp and where it suffers from rainfall.
- Do not install the washing machine in place where it suffers from the sun directly, in which plastic or components will be damaged. It will be shortened the life of your washing machine.
- Do not install the washing machine in place where temperatures below freezing may occur. Frozen hoses may burst or split. The reliability of the electronic control unit may be impaired at temperatures below freezing point.
- Do not shoot the washing machine with water when you clean it.
- Keep the washing machine away from fire or heat sources.
- Before using the washing machine for the first time, check that the transit bolts at the rear of the machine have been removed. During spinning, transit bolts which is still in place may result in damage to both the machine and adjacent furniture or appliances.
- Turn off the tap if the machine is to be left for any length of time (e.g. holiday), especially if there is no floor drain (gully) in the immediate vicinity.
- Take care to ensure that foreign objects (e.g. nails, pins, coins, paper clips) do not find their way into the machine with the laundry. These may damage components of the machine (e.g. drum), which in turn can result in damage to the laundry.
- Do not wash water-repellent things(e.g. raincoats) with washing machine.
- Only remove laundry from the washing machine once the drum has stopped turning. Reaching into a moving drum is extremely dangerous and could result in injury.
- For washing machines having ventilation openings in the base, the washing machines can not be working on the carpet.

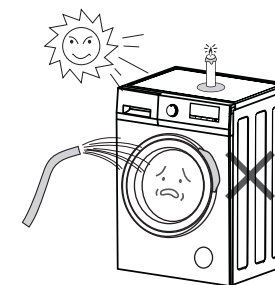

Safety with children

- Keep children away from the washing machine at all times. To avoid the risk of injury do not allow children to play on or near it or to play with its controls. Supervise children whilst you are using it.
- Older children may only use the washing machine if its operation has been clearly explained to them and they are able to use it safely, recognising the dangers of misuse.
- For machines with a 'porthole' door, remember that the porthole glass will be hot when washing at very high temperatures. Do not let children touch it.

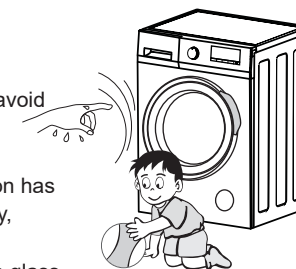

Parts and Features

Before Use

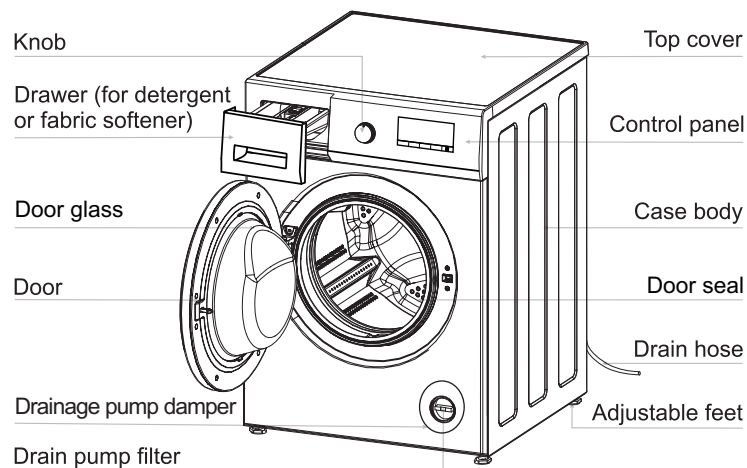

Note Unscrew the drain pump filter to let water run out when the machine is not used for a long time.

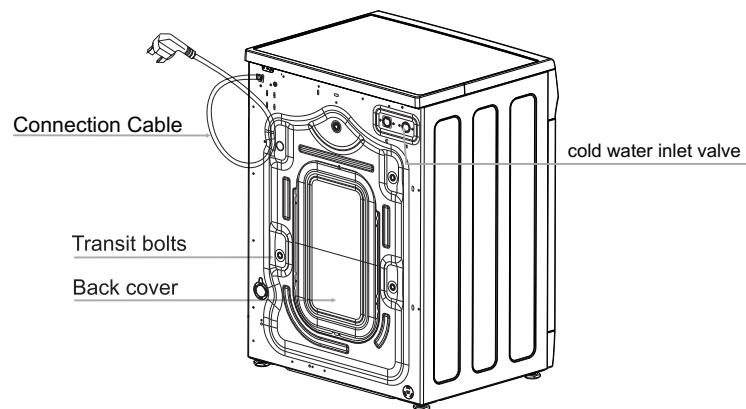

Note The drawing of machine in the manual is only used for instruction. It may be vary from the model you buy.

Installation

Before Use

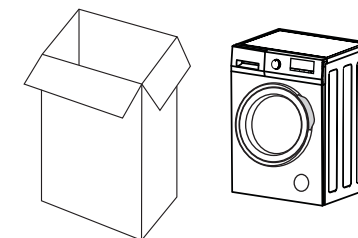

Backout packing

- Remove all the packing (including the foam base) or the vibration and noise may occur.
- Dispose all the wrappage safely and keep them out of the reach of children. Danger of suffocation!
- It is normal that water drops appear on the packing plastic bag and the door glass, which are resulted from the water left in the tub for checking out.

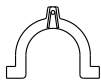

Accessories

Make sure that you have received all of the items shown below.

Accessories	Name	Qty.	Accessories	Name	Qty.
	Inlet hose	1		"U" piece	1
	Transit bolts caps	4		Manual	1

Removing transit bolts

- Remove all the transit bolts at the back of the machine with tools.
- Plug the holes with the transit bolts caps supplied.



Note Strong vibration, noise or failures may occur if the transit bolts are not removed.

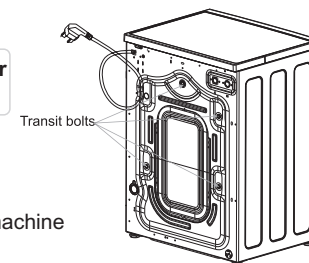

- Keep the transit bolts for future transportation. Whenever the machine is transported, the transit bolts must be refitted.

Installation

Use Process

Installation place requirement

- A concrete floor is the most suitable installation surface for a washing machine, being far less prone to vibration during the spin cycle than wooden floorboards or a carpeted surface.
- The machine must be level and securely positioned. The distance between the machine and wall must be more than 10 cm.
- To avoid vibrations during spinning, the machine should not be installed on soft floor coverings.

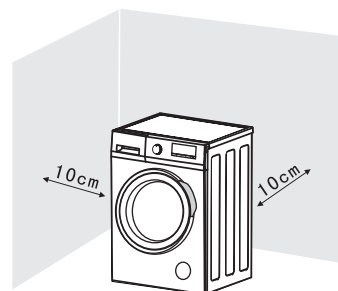

Level adjustment

The machine must stand perfectly level on all four feet to ensure safe and proper operation. Incorrect installation may increase electricity and water consumption and may cause the machine to move about.

To do these when the machine is not level:

- Using the spanner turn locknut in a clockwise direction. Then turn locknuts together with adjust feet to unscrew.
- Use a spirit level to check the machine is standing level.
- Hold adjust feet securely with a pipe wrench. Turn locknut again using the spanner until it sits firmly up against the housing.

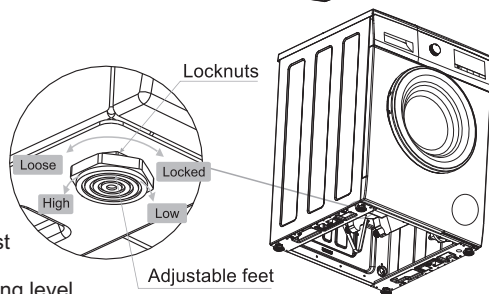

Note Vibration and noise may occur if the locknuts do not sit firmly up against the houses.

Drain hose connection

1. Direct into a sink

If the outlet spigot has not been used before, remove any blanking plug that may be in place.

Push the drain hose onto the spigot and secure with a clip if required, ensure a loop is formed in the drain hose to prevent waste from the sink entering the washing machine.

If required, the drain hose can be extended to a length of 4 m.

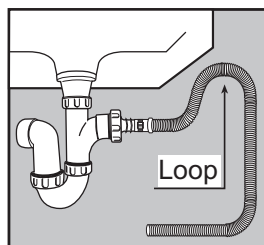
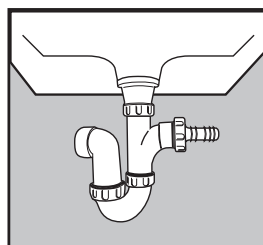

Installation

Use Process

2. Connected securely to a standpipe.

Firstly form a hook in the end of the drain hose using the "U" piece supplied.

Place the drain hose into your standpipe, which should have an internal diameter of approximately 38mm thus ensuring there is an air break between the drain hose and standpipe.

When discharging into a standpipe ensure that the top of the standpipe is no more than 90cm and no less than 60cm above floor level.

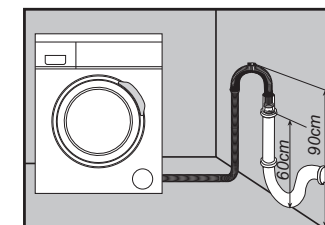
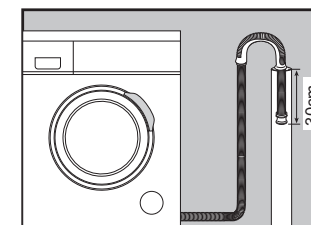

Water inlet connection

Connect the inlet hose supplied with the machine to a tap with a 3/4" thread.

Do not use previously employed hoses.

Installation should comply with local water authority and building regulations' requirements.

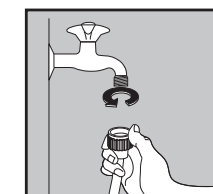
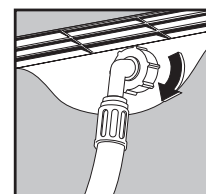

When there is a inlet valve at the back of the machine, it must be connected to a cold water supply. If there are two inlet valve, one is connected to a cold water supply and the other is connected to a hot water supply. Follow the indication of the picture below to complete the connection.

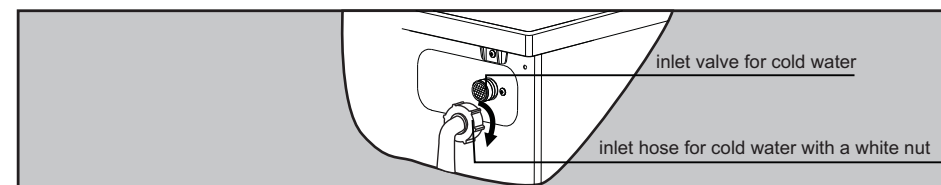

The functions of the control panel

Use Process

The operation panel is used models: XQG90-T512E

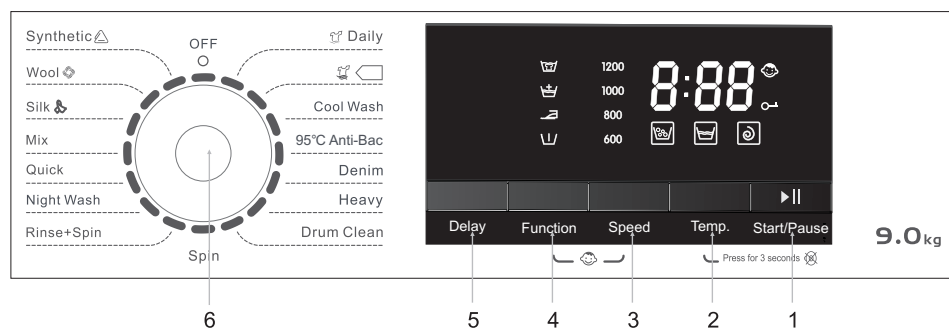

1. Start/Pause (▶||)

Press this button to start or pause a wash cycle. The door can not be open when the machine start. The time will not be recalculated for restarting. If the washing program ending more than 10 minutes without any operation, the machine automatically into sleeping state. Click this button to wake up the screen.

2. Temp.

Press this button repeatedly to change the wash temperature. The detail is in Form on page 9.

3. Speed

Press this button repeatedly to change the spin speed. The detail is in Form on page 9.

4. Function

There are four basic functions and eleven combined functions. They are "Soak", "Rinse+", "Anti-Ironing", "Pre-Wash", "Soak+Rinse+", "Soak+Anti-Ironing" etc. Select a suitable function by pressing this button repeatedly.

Soak

This function is to increase the time of soaking clothes.

Rinse+

This function is to add an extra rinse on the program you selected.

Anti-Ironing

This function is to reduce the wrinkle of clothes during a washing cycle. Once this function is selected, the machine will not execute the last drain unless the "Start/Pause" button is pressed. (Note: The max running time of this function is 12 hours. If it exceeds 12 hours, the machine will drain and spin automatically)

Pre-Wash

This function is to add a washing for very dirty clothes, the washing duration will be prolong.

5. Delay

Press this button repeatedly to set the delay time of the starting of a wash cycle from 1 hour to 24 hours.

6. Knob

Turn this knob clockwise or anticlockwise to select the required wash program. Once the "Start/Pause" button is pressed and the machine is running, the program can not be changed. The detail is in Form on page 10. (Note: At the end of a wash cycle, the knob must be turned to the position "O")

The functions of the control panel

Use Process



Note

For your safety, please not turn the knob to the position "O" and get clothes while the machine is running. Because the temperature of water may be high and it may scald you. The door lock will open automatically at the end of a wash cycle while the temperature of the drum is cool down.

● Child lock ("Speed" + "Function")

The function of "Child lock" is to lock the control panel to prevent the misuse by children.

How to start this function:

1. press the "Speed" and "Function" buttons at the same time for 3 seconds. When the icon "🔒" is lighted up on the screen, the function works.
2. When this function works, all keys and knob are not available, except for the knob turn to the position "O".
3. This function can be selected during a washing cycle.

How to cancel this function:

Press the "Speed" and "Function" buttons at the same time for 3 seconds.

The function is canceled when the icon "🔒" disappears on the screen.

● Mute ("Temp.")

The function of "Mute" is to close all the prompt tone and alert sounds.

How to start this function: Press the "Temp." buttons for 3 seconds.

How to cancel this function: Press the "Temp." buttons for 3 seconds again.

Display icon

Icon	Icon explanation
8:88	Digital display: this area will show the procedure remaining time, delay hour and temperature.
🔒	Child lock: this icon will shinning once child lock function is selected, otherwise will gone.
🔑	Door lock: this icon will shinning when door lock is working, otherwise will gone.
1200-600	Spin speed: show the speed number of spinning.
🧺	Soak: this icon will shinning when soak function is selected, 15min more soaking time before main wash program, it can gain a better washing result.
🧺	Rinse+: this icon will shinning when it is selected. Rinse one more time.
🧺	Ironing free: this icon will shinning when it is selected. This function can avoid crease. Water-stayed 12 hour after rinsing. It will continue the next program after 12 hours or "Start" button is pressed.
🧺	Pre-wash: this icon will shinning when it is selected. Rinse one more time before main wash program.
🧺	Main wash: The logo will be bright in standby condition when selected the program with main wash function, the logo will be flicked when machine during operation, and the logo will stay bright when machine in pause condition, the logo will be turn off when machine finishes operation.
🧺	Rinse: The logo will be bright in standby condition when selected the program with rinse function, the logo will be flicked when machine during operation, and the logo will stay bright when machine in pause condition, the logo will be turn off when machine finishes operation.
🧺	Final spin: The logo will be bright in standby condition, the logo will be flicked when machine during operation, and the logo will stay bright when machine in pause condition, the logo will be turn off when machine finishes operation.

The functions of the control panel

Use Process

The selectable options and functions of different programs

Program	Weight (kg)	Time (min)	Temp (°C)	Rinse times	Spin speed(rpm)	Function Options				
						Delay	Soak	Rinse+	Anti-Ironing	Pre-wash
Daily	9	80	00/20/40/60/95	2	0/600/800/1000/1200	●	● (+15min)	●	●	●
☐	9	197	00/20/40/60/95	3	0/600/800/1000/1200	●	● (+15min)	●	●	●
Cool Wash	6.5	57	00	2	0/600/800/1000/1200	●	● (+15min)	●	●	●
95°C Anti-Bac	5	131	95	2	0/600/800/1000/1200	●	● (+15min)	●	●	●
Denim	5	100	00/20/40	4	0/600/800	●	● (+15min)	●	●	●
Heavy	9	99	00/20/40/60	3	0/600/800/1000/1200	●	● (+15min)	●	●	●
Drum Clean	0	74	00/20/40/60/95	2	0/600/800/1000/1200	●		●		
Spin	9	11	---	0	0/600/800/1000/1200	●				
Rinse+Spin	9	16	---	1	0/600/800/1000/1200	●		●	●	
Night Wash	7	81	00/20/40/60	5	0/600/800	●	● (+15min)	●	Required	
Quick	3	15	00/20/40	1	0/600/800/1000/1200	●	● (+15min)	●	●	
Mix	5	63	00/20/40/60	3	0/600/800	●	● (+15min)	●	●	●
Silk	3.5	48	00/20/40	2	0/600	●	● (+15min)	●	●	
Wool	3.5	50	00/20/40	2	0/600	●	● (+15min)	●	●	
Synthetic	4.5	51	00/20/40/60	2	0/600/800	●	● (+15min)	●	●	●

How to use washer

Use Process

Note:

☐ is for Standard Cotton program.

Standard Cotton at 60 °C and 40 °C are suitable to clean normally soiled cotton laundry and they are the most efficient programs in terms of combined energy and water consumptions for washing that type of cotton laundry; in addition, the actual water temperature may differ from the declared cycle temperature.

The running time above is for the default programs, which is only for reference, and it may differ because of different laundries, weights and washing temperature. The "00" means the temperature of water is normal. The default options of the programs are in boldface.

Before washing clothes for the first time, you must run a complete cycle without clothes.

To do these:

1. Connect the power and turn on the tap.
2. Turn the knob to position "Daily".
3. Press " start / pause " .

It can remove the water which is left in the tub because of manufacturer's checking out.

Washing preparation

1. Connect the inlet hoses well and turn on the tap.
2. After making sure the power socket is grounded reliably, insert the power plug into the power socket.
3. Place the drain hose well.

Preparation of clothes

1. Sort the laundry by colour and by care label. Most garments have a textile care label in the collar or side seam.
2. Make sure all the pockets are empty, Foreign objects (e.g. nails, coins, paper clips, etc.) can cause damage to garments and components in the machine.
3. Close any zips, fasten hooks and eyes etc before washing.
4. Dark textiles often contain excess dye and should be washed separately several times before being included in a mixed load. Always wash whites and coloureds separately.
5. Badly soiled areas, stains etc. should be pre-treated with liquid detergent, stain removers etc.
6. Turn over the clothes which pill easily and is with woolen surface before putting them into the machine.

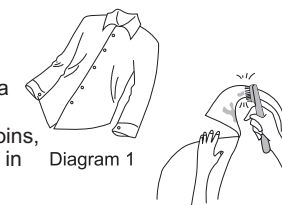

Diagram 1

Diagram 2



Diagram 3

Put clothes into the washer

Unfold the laundry and load loosely in the drum. Mixing both large and small items gives better wash results and also helps distribute the load evenly during spinning. The most efficient use of energy and water is achieved when a full load is washed. However, do not overload as this causes creases and reduces cleaning efficiency.

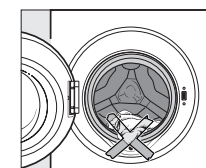

Note

Make sure that no garments are caught between the door and the seal.

How to use washer

Use Process

Using the detergent drawer

1. Open the drawer and add adequate detergent into main wash compartment marked “” or “II”.
2. Add the fabric softener into compartment marked “” or “”. Do not exceed the maximum level mark.
3. Add the detergent into the pre-wash compartment marked “” or “I” according to the programme you select.
4. Close the drawer.

The right amount to dispenser will depend on the following:

- The quantity of laundry
- The soiling level of the laundry
 - Lightly soiled
No visible dirt or stains. Possibly slight body odour.
 - Normally soiled
Visibly dirty and/or just a few slight stains.
 - Heavily soiled
Visible dirt and stains and/or dried on soiling.
- The water hardness level.

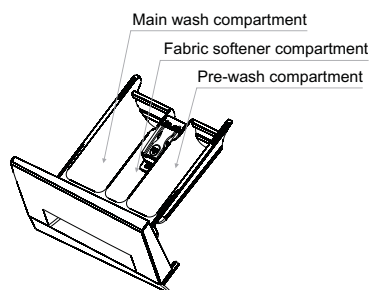

It is recommended to use low foaming powder for all washing temperature programs.

Washing steps

1. Turn on the water tap, and connect the power.
2. Open the door, and put the cloth into the drum one by one.
3. Close the door, and put suitable amount of detergent and fabric softener into the dispenser, then close the drawer.
4. Choose a programme you need by turning the knob .
5. Press the “Temp.” button and select a wash temperature.
6. Press “ Start/Pause” button to start the washing machine.
7. When the cycle is finished, there is a warning tone sounds.



When washing cycle is finished, the machine will change into a standby mode. And the machine will be sleeping after 10 minutes without any control on the control panel.

How to use washer

Use Process

Washing programme chart

Programme	Washing symbol	Fabric
Daily		Cottons, linens or cotton mix fabrics, e.g. table linen, towelling, underwear, T-shirts etc.
Quick		Small loads of items which require freshening up and which can be washed in a Cotton programme.
Rinse+Spin		This programme can be used for rinsing items which can be washed in a Cotton programme. Do not add any detergent.
Spin		Separate spin for cotton and linen items
Standard Cotton		Cottons, linens or cotton mix fabrics, e.g. table linen, towelling, underwear, T-shirts etc.
Synthetic		Synthetic or mixed fabrics, underwear, coloured garments, non-shrink shirts.
Wool		Machine-washable or hand-washable wool or wool blend fabrics. If the care label does not specify a temperature, wash using the cold setting. Also suitable for hand-washable silks. Reduce the spin speed.



The machine is fitted with a balance control device, which ensures the machine is stable during the spin. To protect the machine, it will cut in if the laundry is not evenly distributed in the drum. The laundry is redistributed by reverse rotation of the drum. This may happen several times before the unbalance disappears and normal spinning can resume. If, after 15 minutes, the laundry is still not evenly distributed in the drum, the machine will not spin. In this case, redistributed the load manually and reselect the spin programme.

Door lock

- When the machine is started, the door lock is locked though you press the “Start/Pause” button. Turn the knob to position “O”, the machine and the door lock is unlocked in two minutes.
- When the temperature inside the drum is above 53°C, the door lock is locked.
- When the water is above a certain level, the door lock is locked.
- When the washing cycle is finished, the door lock is unlocked after two minutes.

Important:

Do not try to open the door when the washing cycle is not finished or power supply is cut off during the washing cycle, because the temperature may be high and you may be scalded.

Cleanness and Maintenance

Use Process

! Disconnect the machine from the mains electricity supply and withdraw the plug from the socket before cleaning the machine.

! The washing machine must not be hosed down.

Cleaning the exterior

Clean the exterior with a mild non-abrasive cleaning agent or soap and water using a well wrung-out cloth. Wipe dry with a soft cloth.

! Do not use solvents, abrasive cleaners, glass cleaners or all-purpose cleaning agents. These might damage plastic surfaces and other components because of the chemicals they contain.

The washing drum

Clean the drum every 3 months by using the "Drum clean" programme.

Cleaning the drawer

Remove detergent residues regularly. Clear the drawer following these:

- Pull out the drawer until a resistance is felt. Press down the release catch and at the same time pull the drawer right out of the machine.
- Remove the siphon from compartment and clean it.
- Clean the dispenser using a brush and warm water.

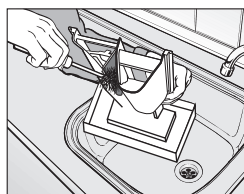
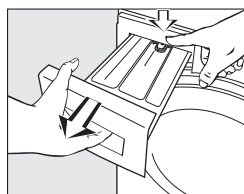

Cleanness and Maintenance

After Use

Cleaning the drawer housing

Use a bottle brush to remove detergent residues inside the drawer housing.

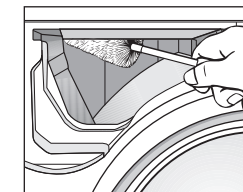

Cleaning the water inlet filter

Use pointed nose pliers to withdraw the plastic filter. Clean, put back and secure. These filter should be checked every 6 months or so, or more often if there are frequent interruptions to the water supply.

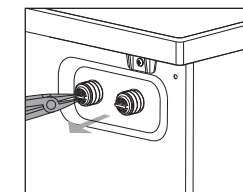

The filter must be put back in place after cleaning.

Cleaning the drain pump filter

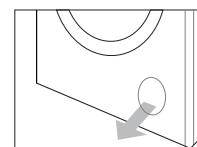

1. Disconnect the machine from the mains electricity supply and open the lower cover with a screwdriver.

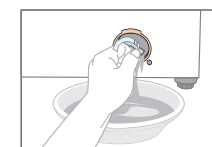

2. Place a container under the pump. Unscrew and remove the filter.

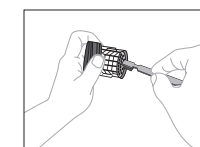

3. Clean the filter carefully.



The filter should be cleaned every 2 months or so, or when there is a fault that the "E03" is on the screen.

Important:

If the machine is exposed to temperatures below 0°C, certain precautions should be taken.

1. Turn off the water tap.
2. Unscrew the inlet hose.
3. Unhook the drain hose from the rear support and position the end of this hose and that of the inlet hose in a bowl. Run the spin programme.
4. Disconnect the appliance.
5. Screw the inlet hose and reposition the drain hose.
6. When you intend to start the machine up again, make sure that the room temperature is above 0°C.

Troubleshooting guide

Difficult explanation

Problem	Error Code	Possible Cause	Solutions
The machine fills overtime.	"E01" is on the screen.	<ol style="list-style-type: none"> 1. The water tap is not open. 2. The drain hose is put down. 3. The water inlet valve is damaged. 	<ol style="list-style-type: none"> 1. Open the water tap. 2. hook up the hose. 3. Change the water inlet valve.
There is a Door lock alarm.	"E02" is on the screen.	<ol style="list-style-type: none"> 1. The door is not locked well. 2. garment is caught between the door and the seal. 3. The door lock is damaged. 	<ol style="list-style-type: none"> 1. Lock the door well. 2. Put the garment into the drum. 3. Change the door lock.
The machine drains overtime.	"E03" is on the screen.	<ol style="list-style-type: none"> 1. The drain hose is squashed or kinked. 2. The drain pump filter is block. 3. The drainage system pipes are blocked. 	<ol style="list-style-type: none"> 1. Check the drain hose. 2. Clean the filter. 3. Check the drainage system and clean it.
Water overflows the machine. / Water sensor works abnormal.	"E04" is on the screen.	<ol style="list-style-type: none"> 1. The water inlet valve is damaged. 2. The connection between the water sensor and wire is not secure. 3. The water sensor is damaged. 	<ol style="list-style-type: none"> 1. Change the water inlet. 2. Check the connection and ensure it is secure. 3. Change the water sensor.
The motor does not work.	"E05" is on the screen.	<ol style="list-style-type: none"> 1. The connection between the motor and wire is not secure. 2. The motor is protected because of over-heat. 3. The motor is damaged. 	<ol style="list-style-type: none"> 1. Check the connection and ensure it is secure. 2. Check if the machine is overloaded. Switch off the machine, and retry when the motor becomes cool. 3. Change the motor.
There is a heating tube fault.	"E06" is on the screen.	<ol style="list-style-type: none"> 1. The connection between the heating tube and wire is not secure. 2. The heating tube is damaged. 	<ol style="list-style-type: none"> 1. Check the connection and ensure it is secure. 2. Change the heating tube.
There is a temperature sensor fault.	"E07" is on the screen.	<ol style="list-style-type: none"> 1. The connection between the temperature sensor and wire is not secure. 2. The temperature sensor is damaged. 	<ol style="list-style-type: none"> 1. Check the connection and ensure it is secure. 2. Change the temperature sensor.

Technical parameters

Appendix

Model	360490 / 360491
Parameter	
Power	220V-240V~50,Hz
Washing / spin capacity	9.0kg
Rated power	2100W
Water pressure	0.02-0.8MPa
Net weight / gross weight	66kg/70kg
Outer dimension (W x D x H) mm	595X545X845



Energy-efficient test program entrance guide:

choose the program " set the temperature to "60°C" and select the spin speed to "1200rpm".

Note:

Data can vary from the nominal values given depending on water pressure, water hardness, water inlet temperature, room temperature, type and volume of load, fluctuations in the electricity supply and any extra options selected.

Symbol explanation

V	Volt	~	Alternating current
W	Watt	Hz	Hertz
	C-Tick		CE symbol

Environmental Protection

Correct Disposal of this product



This marking indicates that this product should not be disposed with other household wastes throughout the EU. To prevent possible harm to the environment or human health from uncontrolled waste disposal, recycle it responsibly to promote the sustainable reuse of material resources. To return your used device, please use the return and collection systems or contact the retailer where the product was purchased. They can take this product for environmental safe recycling.

Electric Diagram

Appendix

The wiring diagram is used models:

